

A Shure Educational Publication

Mic Techniques

Microphone

Techniques

for

Studio

Recording



SHURE[®]

INTRODUCTION	4
MICROPHONE TECHNIQUES	4
MICROPHONE PLACEMENT	8
MICROPHONE CHARACTERISTICS	20
INSTRUMENT CHARACTERISTICS	23
ACOUSTIC CHARACTERISTICS	24
MICROPHONE SELECTION GUIDE	28
GLOSSARY	29
APPENDIX	33

Introduction

The selection and placement of microphones can have a major influence on the sound of an acoustic recording. It is a common view in the recording industry that the music played by a skilled musician with a quality instrument properly miked can be sent directly to the recorder with little or no modification. This simple approach can often sound better than an instrument that has been reshaped by a multitude of signal processing gear.

In this guide, Shure Application Engineers describe particular microphone techniques and placement: techniques to pick up a natural tonal balance, techniques to help reject unwanted sounds, and even techniques to create special effects.

Following this, some fundamentals of microphones, instruments, and acoustics are presented.

SECTION ONE

Microphone Techniques

Here is a very basic, general procedure to keep in mind when miking something that makes sound:

- 1) Use a microphone with a frequency response that is suited to the frequency range of the sound, if possible, or filter out frequencies above and/or below the highest and lowest frequencies of the sound.
- 2) Place the microphone at various distances and positions until you find a spot where you hear from the studio monitors the desired tonal balance and the desired amount of room acoustics. If you don't like it, try another position, try another microphone, try isolating the instrument further, or change the sound of the instrument itself. For example, replacing worn out strings will change the sound of a guitar.
- 3) Often you will encounter poor room acoustics, or pickup of unwanted sounds. In these cases, place the microphone very close to the loudest part of the instrument or isolate the instrument. Again, experiment with microphone choice, placement and isolation, to minimize the undesirable and accentuate the desirable direct and ambient acoustics.

Microphone technique is largely a matter of personal taste. Whatever method *sounds* right for the particular sound, instrument, musician, and song *is* right. There is no one ideal way to place a microphone. There is also no one ideal microphone to use on any particular instrument. Choose and place the microphone to get the sound you want. We recommend experimenting with all sorts of microphones and positions until you create your desired sound. However, the desired sound can often be achieved more quickly by understanding basic microphone characteristics, sound-radiation properties of musical instruments, and basic room acoustics.

Vocal Microphone Techniques

Individual Vocals

Microphones with various polar patterns can be used in vocal recording techniques. Consider recording a choral group or vocal ensemble. Having the vocalists circle around an omnidirectional mic allows well trained singers to perform as they would live: creating a blend of voices by changing their individual singing levels and timbres. Two cardioid mics, positioned back to back could be used for this same application.

An omnidirectional mic may be used for a single vocalist as well. If the singer is in a room with ambience and reverb that add to the desired effect, the omnidirectional mic will capture the room sound as well as the singer's direct voice. By changing the distance of the vocalist to the microphone, you can adjust the balance of the direct voice to the ambience. The closer the vocalist is to the mic, the more direct sound is picked up relative to the ambience.

The standard vocal recording environment usually captures the voice only. This typically requires isolation and the use of a unidirectional mic. Isolation can be achieved with baffles surrounding the vocalist like a "shell" or some other method of reducing reflected sound from the room. Remember even a music stand can cause reflections back to the mic.

The axis of the microphone should usually be pointed somewhere between the nose and mouth to pick up the complete sound of the voice. Though the mic is usually directly in front of the singer's mouth, a slightly off-axis placement may help to avoid explosive sounds from breath blast or certain consonant sounds such as "p", "b", "d", or "t". Placing the mic even further off-axis, or the use of an accessory pop filter, may be necessary to fully eliminate this problem.

While many vocals are recorded professionally in an isolation booth with a cardioid condenser microphone, other methods of vocal recording are practiced. For instance, a rock band's singers may be uncomfortable in the isolated environment described earlier. They may be used to singing in a loud environment with a monitor loudspeaker as the reference. This is a typical performance situation and forces them to sing louder and push their voices in order to hear themselves. This is a difficult situation to recreate with headphones.

A technique that has been used successfully in this situation is to bring the singers into the control room to perform. This would be especially convenient for project studios that exist in only one room. Once in that environment, a supercardioid dynamic microphone could be used in conjunction with the studio monitors. The singer faces the monitors to hear a mix of music and voice together. The supercardioid mic rejects a large amount of the sound projected from the speakers if the rear axis of the microphone is aimed between the speakers and the speakers are aimed at the null angle of the mic (about 65 degrees on either side of its rear axis). Just as in live sound, you are using the polar pattern of the mic to improve gain-before-feedback and create an environment that is familiar and encouraging to the vocalists. Now the vocalist can scream into the late hours of the night until that vocal track is right.

Ensemble Vocals

A condenser is the type of microphone most often used for choir applications. They are generally more capable of flat, wide-range frequency response. The most appropriate directional type is a unidirectional, usually a cardioid. A supercardioid or a hypercardioid microphone may be used for a slightly greater reach or for more ambient sound rejection. Balanced low-impedance output is used exclusively, and the sensitivity of a condenser microphone is desirable because of the greater distance between the sound source and the microphone.

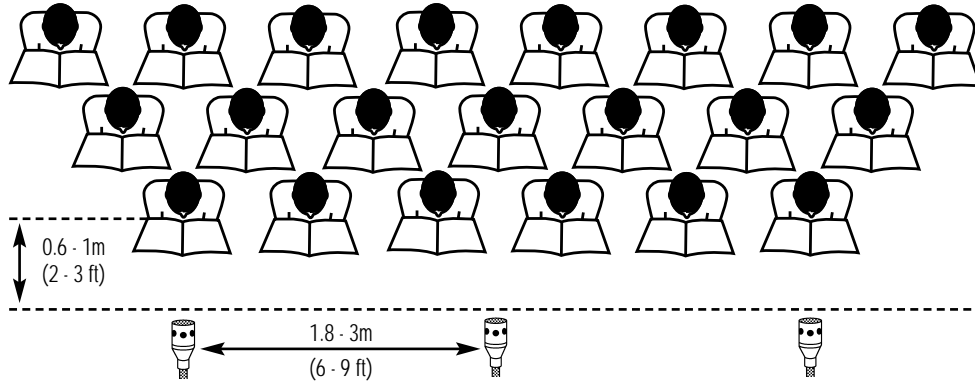

Choir microphone positions - top view

Application of choir microphones falls into the category known as “area” coverage. Rather than one microphone per sound source, the object is to pick up multiple sound sources (or a “large” sound source) with one (or more) microphone(s). Obviously, this introduces the possibility of interference effects unless certain basic principles (such as the “3-to-1 rule”) are followed, as discussed below.

For one microphone picking up a typical choir, the suggested placement is a few feet in front of, and a few feet above, the heads of the first row. It should be centered in front of the choir and aimed at the last row. In this configuration, a cardioid microphone can “cover” up to 15-20 voices, arranged in a rectangular or wedge-shaped section.

For larger or unusually shaped choirs, it may be necessary to use more than one microphone. Since the pickup angle of a microphone is a function of its directionality (approximately 130 degrees for a cardioid), broader coverage requires more distant placement.

In order to determine the placement of multiple microphones for choir pickup, remember the following rules: **observe the 3-to-1 rule (see glossary); avoid picking up the same sound source with more than one microphone;** and finally, **use the minimum number of microphones.**

For multiple microphones, the objective is to divide the choir into sections that can each be covered by a single microphone. If the choir has any existing physical divisions (aisles or boxes), use these to define basic sections.

If the choir is grouped according to vocal range (soprano, alto, tenor, bass), these may serve as sections.

If the choir is a single, large entity, and it becomes necessary to choose sections based solely on the coverage of the individual microphones, use the following spacing: one microphone for each lateral section of approximately 6 to 9 feet. If the choir is unusually deep (more than 6 or 8 rows), it may be divided into two vertical sections of several rows each, with aiming angles adjusted accordingly. In any case, **it is better to use too few microphones than too many.**

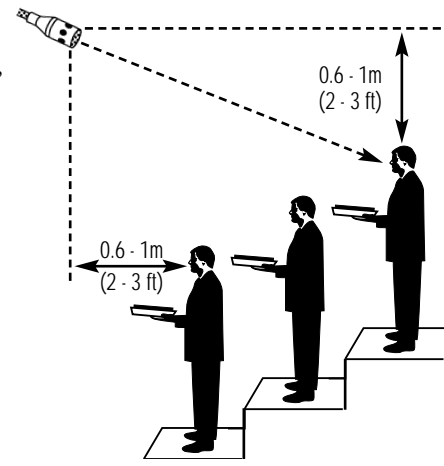

Microphone positions - side view

Acoustic String and Fretted Instruments

Experimentation with mic placement provides the ability to achieve accurate and pleasing sound reproduction on these complex sound sources. It is also an opportunity for exploring sound manipulation, giving the studio engineer many paths to the final mix. Whether you are involved in a music studio, a commercial studio, or a project studio, you should continue to explore different methods of achieving the desired results. The possibilities are limited only by time and curiosity.

Acoustic Guitar (Also Dobro, Dulcimer, Mandolin, Ukelele)

When recording an acoustic guitar, try placing one mic three to six inches away, directly in front of the sound hole. Then put another microphone, of the same type, four feet away.

This will allow you to hear the instrument and an element of room ambience. Record both mics dry and flat (no effects or EQ), each to its own track. These two tracks will sound vastly different. Combining them may provide an open sound with the addition of the distant mic. Giving the effect of two completely different instruments or one in a stereo hallway may be achieved by enhancing each signal with EQ and effects unique to the sound you want to hear.

Try the previously mentioned mic technique on any acoustic instrument. Attempt to position the mic in different areas over the instruments, listening for changes in timbre. You will find different areas offer different tonal characteristics. Soon you should develop “an ear” for finding instruments’ sweet spots. In addition, the artist and style of music should blend with your experiences and knowledge to generate the desired effect.

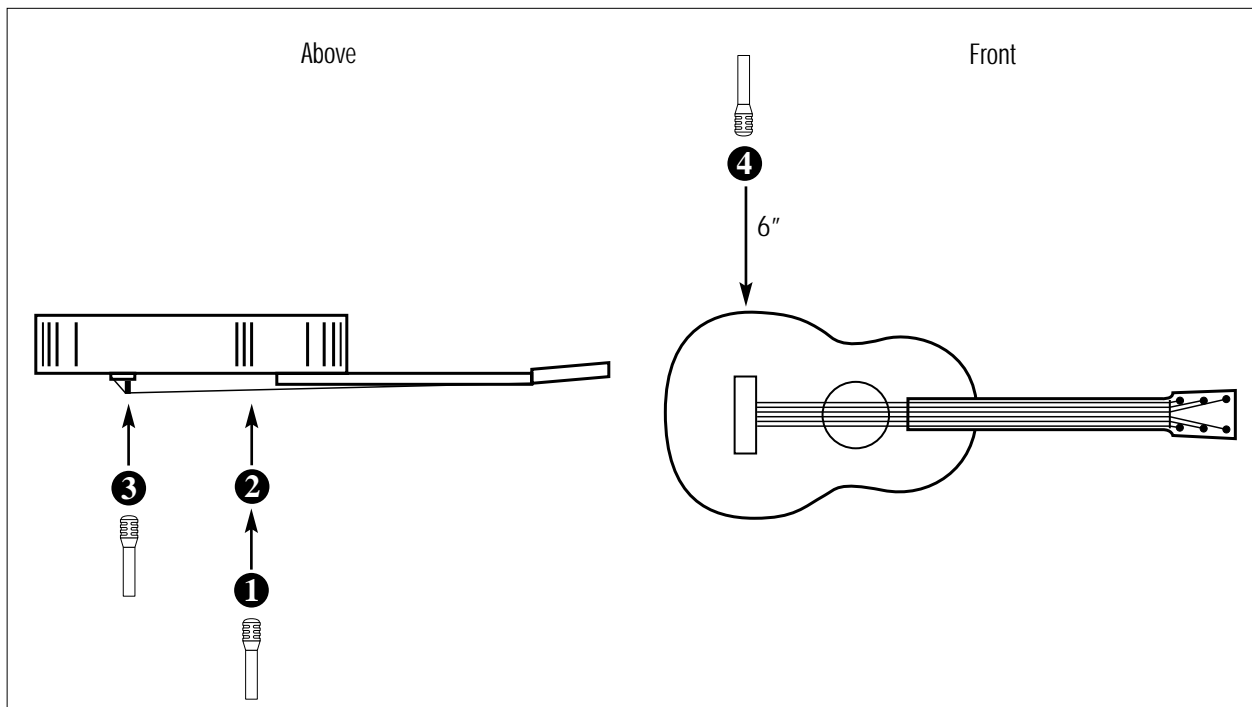

Various microphone positions for acoustic guitar

Acoustic Guitar:

Microphone Placement	Tonal Balance	Comments
❶ 8 inches from sound hole	Bassy	Good starting placement when leakage is a problem. Roll off bass for a more natural sound (more for a uni than an omni).
❷ 3 inches from sound hole	Very bassy, boomy, muddy, full	Very good isolation. Bass roll-off needed for a natural sound.
❸ 4 to 8 inches from bridge	Woody, warm, mellow. Mid-bassy, lacks detail	Reduces pick and string noise.
❹ 6 inches above the side, over the bridge, and even with the front soundboard	Natural, well-balanced, slightly bright	Less pickup of ambiance and leakage than 3 feet from sound hole.
Miniature microphone clipped outside of sound hole	Natural, well-balanced	Good isolation. Allows freedom of movement.
Miniature microphone clipped inside sound hole	Bassy, less string noise	Reduces leakage. Test positions to find each guitar's sweet spot.

Banjo:

3 inches from center of head	Bassy, thumpy	Limits leakage. Roll off bass for natural sound.
3 inches from edge of head	Bright	Limits leakage.
Miniature microphone clipped to tailpiece aiming at bridge	Natural	Limits leakage. Allows freedom of movement.

Violin (Fiddle):

A few inches from side	Natural	Well-balanced sound.
------------------------	---------	----------------------

Cello:

1 foot from bridge	Well-defined	Well-balanced sound, but little isolation.
--------------------	--------------	--

All String Instruments:

Miniature microphone attached to strings between bridge and tailpiece	Bright	Minimizes feedback and leakage. Allows freedom of movement.
---	--------	---

Acoustic Bass: (Upright Bass, String Bass, Bass Violin)

Microphone Placement	Tonal Balance	Comments
6 inches to 1 foot out front, just above bridge	Well-defined	Natural sound.
A few inches from f-hole	Full	Roll off bass if sound is too boomy.
Wrap microphone in foam padding (except for grille) and put behind bridge or between tailpiece and body	Full, "tight"	Minimizes feedback and leakage.

Harp:

Aiming toward player at part of soundboard, about 2 feet away	Natural	See "Stereo Microphone Techniques" section for other possibilities.
Tape miniature microphone to soundboard	Somewhat constricted	Minimizes feedback and leakage.

Acoustic Pianos

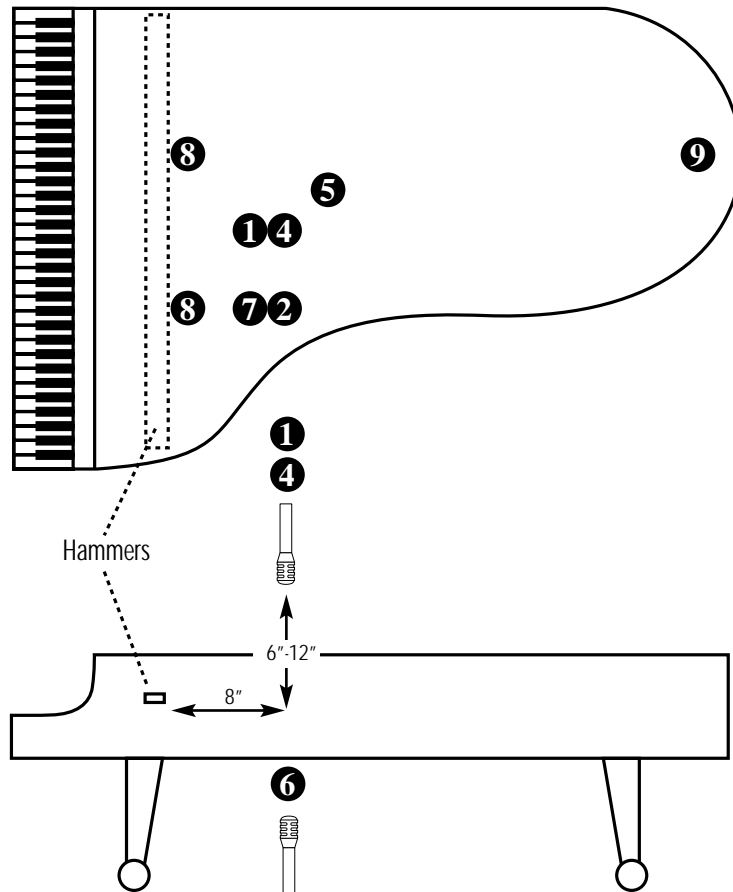

Grand Piano:

Microphone Placement	Tonal Balance	Comments
<p>❶ 12 inches above middle strings, 8 inches horizontally from hammers with lid off or at full stick</p>	<p>Natural, well-balanced</p>	<p>Less pickup of ambience and leakage than 3 feet out front. Move microphone(s) farther from hammers to reduce attack and mechanical noises. Good coincident-stereo placement. See “Stereo Microphone Techniques” section.</p>
<p>❷ 8 inches above treble strings, as above</p>	<p>Natural, well-balanced, slightly bright</p>	<p>Place one microphone over bass strings and one over treble strings for stereo. Phase cancellations may occur if the recording is heard in mono.</p>
<p>❸ Aiming into sound holes</p>	<p>Thin, dull, hard, constricted</p>	<p>Very good isolation. Sometimes sounds good for rock music. Boost mid-bass and treble for more natural sound.</p>
<p>❹ 6 inches over middle strings, 8 inches from hammers, with lid on short stick</p>	<p>Muddy, boomy, dull, lacks attack</p>	<p>Improves isolation. Bass roll-off and some treble boost required for more natural sound.</p>
<p>❺ Next to the underside of raised lid, centered on lid</p>	<p>Bassy, full</p>	<p>Unobtrusive placement.</p>
<p>❻ Underneath the piano, aiming up at the soundboard</p>	<p>Bassy, dull, full</p>	<p>Unobtrusive placement.</p>
<p>❼ Surface-mount microphone mounted on underside of lid over lower treble strings, horizontally, close to hammers for brighter sound, further from hammers for more mellow sound</p>	<p>Bright, well-balanced</p>	<p>Excellent isolation. Experiment with lid height and microphone placement on piano lid for desired sounds.</p>
<p>❽ Two surface-mount microphones positioned on the closed lid, under the edge at its keyboard edge, approximately 2/3 of the distance from middle A to each end of the keyboard</p>	<p>Bright, well-balanced, strong attack</p>	<p>Excellent isolation. Moving “low” mic away from keyboard six inches provides truer reproduction of the bass strings while reducing damper noise. By splaying these two mics outward slightly, the overlap in the middle registers can be minimized.</p>
<p>❾ Surface-mount microphone placed vertically on the inside of the frame, or rim, of the piano, at or near the apex of the piano’s curved wall</p>	<p>Full, natural</p>	<p>Excellent isolation. Minimizes hammer and damper noise. Best if used in conjunction with two surface-mount microphones mounted to closed lid, as above.</p>

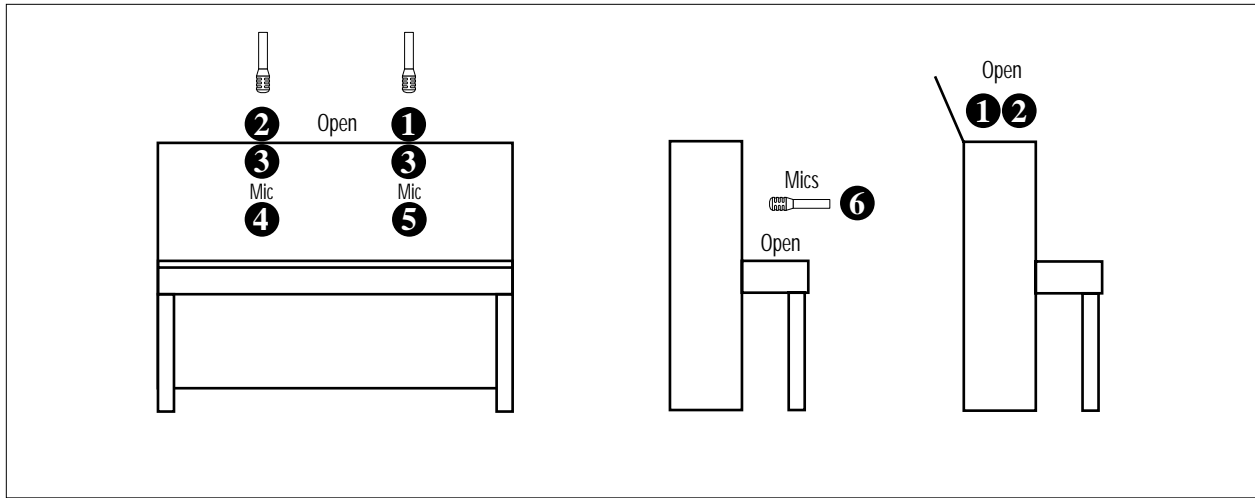

Upright Piano:

Microphone Placement	Tonal Balance	Comments
1 Just over open top, above treble strings	Natural (but lacks deep bass), picks up hammer attack	Good placement when only one microphone is used.
2 Just over open top, above bass strings	Slightly full or tubby, picks up hammer attack	Mike bass and treble strings for stereo.
3 Inside top near the bass and treble strings	Natural, picks up hammer attack	Minimizes feedback and leakage. Use two microphones for stereo.
4 8 inches from bass side of soundboard	Full, slightly tubby, no hammer attack	Use this placement with the following placement for stereo.
5 8 inches from treble side of soundboard	Thin, constricted, no hammer attack	Use this placement with the preceding placement for stereo.
1 foot from center of soundboard on hard floor or one-foot-square plate on carpeted floor, aiming at piano (soundboard should face into room)	Natural, good presence	Minimize pickup of floor vibrations by mounting microphone in low-profile shock-mounted microphone stand.
6 Aiming at hammers from front, several inches away (remove front panel)	Bright, picks up hammer attack	Mike bass and treble strings for stereo.

Woodwinds

Saxophone:

Microphone Placement	Tonal Balance	Comments
<p>With the saxophone, the sound is fairly well distributed between the finger holes and the bell. Miking close to the finger holes will result in key noise. The soprano sax must be considered separately because its bell does not curve upward. This means that, unlike all other saxophones, placing a microphone toward the middle of the instrument will not pick-up the sound from the key holes and the bell simultaneously. The saxophone has sound characteristics similar to the human voice. Thus, a shaped response microphone designed for voice works well.</p>		
A few inches from and aiming into bell	Bright	Minimizes feedback and leakage.
A few inches from sound holes	Warm, full	Picks up fingering noise.
A few inches above bell and aiming at sound holes	Natural	Good recording technique.
Miniature microphone mounted on bell	Bright, punchy	Maximum isolation, up-front sound.

Flute:

The sound energy from a flute is projected both by the embouchure and by the first open fingerhole. For good pickup, place the mic as close as possible to the instrument. However, if the mic is too close to the mouth, breath noise will be apparent. Use a windscreen on the mic to overcome this difficulty.

A few inches from area between mouthpiece and first set of finger holes	Natural, breathy	Pop filter or windscreen may be required on microphone.
A few inches behind player's head, aiming at finger holes	Natural	Reduces breath noise.

Oboe, Bassoon, Etc.:

About 1 foot from sound holes	Natural	Provides well-balanced sound.
A few inches from bell	Bright	Minimizes feedback and leakage.

Woodwinds (continued)

Saxophone:

Microphone Placement	Tonal Balance	Comments
----------------------	---------------	----------

Harmonica

Very close to instrument	Full, bright	Minimizes feedback and leakage. Microphone may be cupped in hands.
--------------------------	--------------	---

Accordian

One or two feet in front of instrument, centered	Full range, natural sound	Use two microphones for stereo or to pick up bass and treble sides separately.
Miniature microphone mounted internally	Emphasizes midrange	Minimizes leakage. Allows freedom of movement.

Brass

The sound from most brass instruments is very directional. Placing the mic off axis with the bell of the instrument will result in less pickup of high frequencies.

Trumpet, Cornet Trombone, Tuba:

Microphone Placement	Tonal Balance	Comments
----------------------	---------------	----------

1 to 2 feet from bell (a couple of instruments can play into one microphone)	On-axis to bell sounds bright; to one side sounds natural or mellow	Close miking sounds “tight” and minimizes feedback and leakage. More distant placement gives fuller, more dramatic sound.
--	---	--

Miniature microphone mounted on bell	Bright	Maximum isolation.
--------------------------------------	--------	--------------------

French Horn:

Microphone aiming toward bell	Natural	Watch out for extreme fluctuations on VU meter.
-------------------------------	---------	---

Amplified Instruments

Another “instrument” with a wide range of characteristics is the loudspeaker. Anytime you are recording a guitar or bass cabinet, you are confronted with the acoustic nature of loudspeakers. A single loudspeaker is directional and displays different frequency characteristics at different angles and distances. On-axis at the center of a speaker tends to produce the most “bite”, while off-axis or edge placement of the microphone produces a more “mellow” sound. A cabinet with multiple loudspeakers has an even more complex output, especially if it has different speakers for bass and treble.

As with most acoustic instruments, the desired sound develops at some distance away from the speaker. The most common approach is to close-mic an individual speaker. This is a habit people develop from viewing or doing live sound. In the live sound environment, most audio sources are close-miked to achieve the highest direct to ambient pickup ratios. Using unidirectional mics for close miking maximizes off-axis sound rejection as well. These elements lead to reduction of potential feedback opportunities. In the recording environment, the loudspeaker cabinet

can be isolated and distant-mic techniques can be used to capture a more representative sound.

Often, by using both a close and a distant (more than a few feet) mic placement at the same time, it is possible to record a sound which has a controllable balance between “presence” and “ambience”.

Placement of loudspeaker cabinets can also have a significant effect on their sound. Putting cabinets on carpets can reduce brightness, while raising them off the floor can reduce low end. Open-back cabinets can be miked from behind as well as from the front. The distance from the cabinet to walls or other objects can also vary the sound. Again, move the instrument and the mic(s) around until you achieve something that you like!

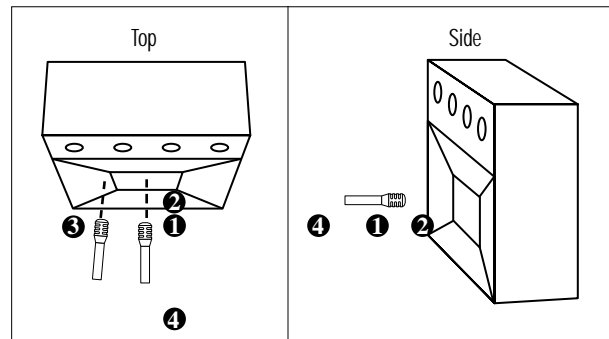

Electric Guitar:

The electric guitar has sound characteristics similar to the human voice. Thus, a shaped response microphone designed for voice works well.

Microphone Placement	Tonal Balance	Comments
① 4 inches from grille cloth at center of speaker cone	Natural, well-balanced	Small microphone desk stand may be used if loudspeaker is close to floor.
② 1 inch from grille cloth at center of speaker cone	Bassy	Minimizes feedback and leakage.
③ Off-center with respect to speaker cone	Dull or mellow	Microphone closer to edge of speaker cone results in duller sound. Reduces amplifier hiss noise.
④ 3 feet from center of speaker cone	Thin, reduced bass	Picks up more room ambience and leakage.
Miniature microphone draped over amp in front of speaker	Emphasized midrange	Easy setup, minimizes leakage.
Microphone placed behind open back cabinet	Depends on position	Can be combined with mic in front of cabinet, but be careful of phase cancellation.

Bass Guitar:

If the cabinet has only one speaker a single microphone should pick up a suitable sound with a little experimentation. If the cabinet has multiple speakers of the same type it is typically easiest to place the microphone to pick up just one speaker.

Placing the microphone between speakers can result in strong phase effects though this may be desirable to achieve a particular tone. However, if the cabinet is stereo or has separate bass and treble speakers multiple microphones may be required.

Electric Keyboard Amp:

Microphone Placement	Tonal Balance	Comments
----------------------	---------------	----------

Aim microphone at speaker as described in Electric Guitar Amplifier section

Depends on brand of piano

Roll off bass for clarity, roll off high frequencies to reduce hiss.

Leslie Organ Speaker:

Aim one microphone into top louvers 3 inches to 1 foot away

Natural, lacks deep bass

Good one-microphone pickup.

Mike top louvers and bottom bass speaker 3 inches to 1 foot away

Natural, well-balanced

Excellent overall sound.

Mike top louvers with two microphones, one close to each side; pan to left and right; mike bottom bass speaker 3 inches to 1 foot away and pan its signal to center

Natural, well-balanced

Stereo effect.

Drums and Percussion

Drum Kit Miking – The drum kit is one of the most complicated sound sources to record. Although there are many different methods, some common techniques and principles should be understood. Since the different parts of the drum kit have widely varying sound they should be considered as individual instruments, or at least a small group of instrument types: Kick, Snare, Toms, Cymbals, and Percussion. Certain mic characteristics are extremely critical for drum usage.

Directionality - Because we want to consider each part of the kit an individual instrument; each drum may have its own mic. Interference effects may occur due to the close proximity of the mics to each other and to the various drums. Choosing mics that can reject sound at certain angles and placing them properly can be pivotal in achieving an overall drum mix with minimal phase problems.

Dynamic Range - A drum can produce very high Sound Pressure Levels (SPLs). The microphone must be able to handle these levels. A dynamic microphone will usually handle high SPLs better than a condenser. Check the Maximum SPL in condenser microphone specifications. It should be at least 130 dB for closeup drum use.

Proximity Effect - Unidirectional mics may have excessive low frequency response when placed very close to the drums. A low frequency roll-off either on the microphone or at the mixer will help cure a “muddied” sound. However, proximity effect may also enhance low frequency response if desired. It can also be used to effectively reduce pickup of distant low frequency sources by the amount of low-rolloff used to control the closeup source. Typically, drums are isolated in their own room to prevent bleed through to microphones on

other instruments. In professional studios it is common for the drums to be raised above the floor. This helps reduce low frequency transmission through the floor.

Here is a basic individual drum miking technique:

1 Bass (Kick) Drums – This drum’s purpose in most music is to provide transient, low-frequency energy bursts that help establish the primary rhythmic pattern of a song. The kick drums’ energy is primarily focused in two areas: very low-end timbre and “attack”. Although this varies by individual drum, the attack tends to be in the 2.5-5kHz range.

A microphone for this use should have good low frequency response and possibly a boost in the attack range, although this can be done easily with EQ. The mic should be placed in the drum, in close proximity (1 - 6 inches), facing the beater head. (position D)

2 Snare Drum – This is the most piercing drum in the kit and almost always establishes tempo. In modern music it usually indicates when to clap your hands! This is an extremely transient drum with little or no sustain to it. Its attack energy is focused in the 4 - 6kHz range.

Typically, the drum is miked on the top head at the edge of the drum with a cardioid or supercardioid microphone. (position C)

3 Hi-Hats – These cymbals are primarily short, high frequency bursts used for time keeping, although the cymbals can be opened for a more loose sound. Many times the overhead mics will provide enough response to the high hat to eliminate the need for a separate hi-hat microphone. If necessary, a mic placed away from the puff of air that happens when hi-hats close and within four inches to the cymbals should be a good starting point. (position G)

Simpler methods of drum miking are used for jazz and any application where open, natural kit sounds are desired. Using fewer mics over sections of the drums is common. Also, one high quality mic placed at a distance facing the

whole kit may capture the sounds of kit and room acoustics in an enjoyable balance. Additional mics may be added to reinforce certain parts of the kit that are used more frequently.

4 Tom Toms – While the kick and snare establish the low and high rhythmic functions, the toms are multiple drums that will be tuned from high to low between the snare and kick. They are primarily used for fills, but may also be consistent parts of the rhythmic structure. The attack range is similar to the snare drum, but often with more sustain.

An individual directional mic on the top head near the edge can be used on each drum and panned to create some spatial imaging. A simpler setup is to place one mic slightly above and directly between two toms. (position E)

5 Overheads – The cymbals perform a variety of sonic duties from sibilant transient exclamation points to high frequency time keeping. In any case, the energy is mostly of a high-frequency content. Flat frequency response condenser microphones will give accurate reproduction of these sounds.

Having microphones with low frequency roll-off will help to reject some of the sound of the rest of the kit which may otherwise cause phase problems when the drum channels are being mixed. The common approach to capturing the array of cymbals that a drummer may use is an overhead stereo pair of microphones. (positions A and B)

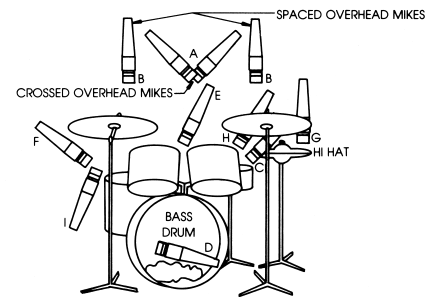

Front view

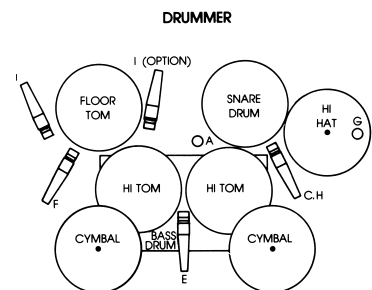

Top view

When there are limited microphones available to record a drum kit use the following guidelines:

Number of microphones	Positioning Alternative (Positioning reference)
One	Use as “overhead” (⑤)
Two	Kick drum and overhead (① and ⑤)
Three	Kick drum, snare, and overhead or kick drum (①, ②, and ⑤)
Four	Kick drum, snare, high hat, and overhead (①, ②, ③, and ⑤)
Five	Kick drum, snare, high hat, tom-toms, and overhead (①, ②, ③, ④, and ⑤)

Timbales, Congas, Bongos:

Microphone Placement	Tonal Balance	Comments
----------------------	---------------	----------

One microphone aiming down between pair of drums, just above top heads	Natural	Provides full sound with good attack.
--	---------	---------------------------------------

Tambourine:

One microphone placed 6 to 12 inches from instrument	Natural	Experiment with distance and angles if sound is too bright.
--	---------	---

Steel Drums:

Tenor Pan, Second Pan, Guitar Pan

One microphone placed 4 inches above each pan	Bright, with plenty of attack	Allow clearance for movement of pan.
---	-------------------------------	--------------------------------------

Microphone placed underneath pan		Decent if used for tenor or second pans. Too boomy with lower voiced pans.
----------------------------------	--	--

Cello Pan, Bass Pan

One microphone placed 4 - 6 inches above each pan	Natural	Can double up pans to a single microphone.
---	---------	--

Xylophone, Marimba, Vibraphone:

Two microphones aiming down toward instrument, about 1 1/2 feet above it, spaced 2 feet apart, or angled 135° apart with grilles touching	Natural	Pan two microphones to left and right for stereo. See “Stereo Microphone Techniques” section.
---	---------	---

Glockenspiel:

One microphone placed 4 - 6 inches above bars	Bright, with lots of attack.	For less attack, use rubber mallets instead of metal mallets. Plastic mallets will give a medium attack.
---	------------------------------	--

Stereo

Stereo Microphone Techniques – One of the most popular specialized microphone techniques is stereo miking. This use of two or more microphones to create a stereo image will often give depth and spatial placement to an instrument or overall recording. There are a number of different methods for stereo. Three of the most popular are the spaced pair (A/B), the coincident or near-coincident pair (X-Y configuration), and the Mid-Side (M-S) technique.

The spaced pair (A/B) technique uses two cardioid or omni directional microphones spaced 3 - 10 feet apart from each other panned in left/right configuration to capture the stereo image of an ensemble or instrument.

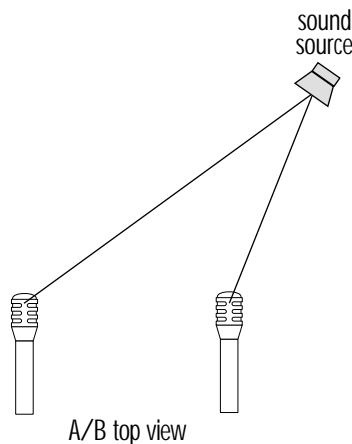

Effective stereo separation is very wide. The distance between the two microphones is dependent on the physical size of the sound source. For instance, if two mics are placed ten feet apart to record an acoustic guitar; the guitar will appear in the center of the stereo image. This is probably too much spacing for such a small sound source. A closer, narrower mic placement should be used in this situation.

The drawback to A/B stereo is the potential for undesirable phase cancellation of the signals from the microphones. Due to the relatively large distance between the microphones and the resulting difference of sound arrival times at the microphones, phase cancellations and summing may be occurring. A mono reference source can be used to check for phase problems. When the program is switched to mono and frequencies

jump out or fall out of the sound, you can assume that there is phase problem. This may be a serious problem if your recording is going to be heard in mono as is typical in broadcast or soundtrack playback.

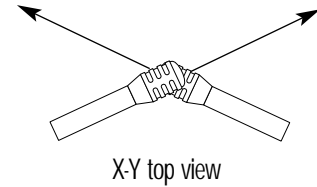

The X-Y technique uses two cardioid microphones of the same type and manufacture with the two mic capsules placed either as close as possible (coincident) or within 12 inches of each other (near-coincident) and facing each other at an angle ranging from 90 - 135 degrees, depending on the size of the sound source and the particular sound desired. The pair is placed with the center of the two mics facing directly at the sound source and panned left and right.

Due to the small distance between the microphones, sound arrives at the mics at nearly the same time, reducing (near coincident) or eliminating (coincident) the possible phase problems of the A/B techniques. The stereo separation of this technique is good but may be limited if the sound source is extremely wide. Mono compatibility is fair (near-coincident) to excellent (coincident).

The M-S or Mid-Side stereo technique involves a cardioid mic element and a bi-directional mic element, usually housed in a single case, mounted in a coincident arrangement. The cardioid (mid) faces directly at the source and picks up primarily on-axis sound while the bi-directional (side) faces left and right and picks up off-axis sound. The two signals are combined via the M-S matrix to give a variable controlled stereo image. By adjusting the level of mid versus side signals, a narrower or wider image can be created without moving the microphone. This technique is completely mono-compatible and is widely used in broadcast and film applications.

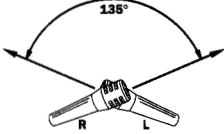
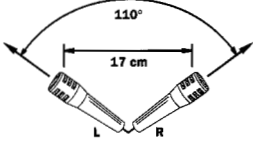
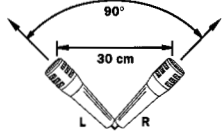
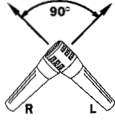
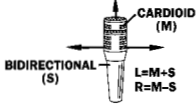
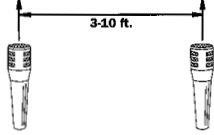
STEREO PICKUP SYSTEMS	MICROPHONE TYPES	MICROPHONE POSITIONS	
X-Y	2 - CARDIOID	AXES OF MAXIMUM RESPONSE AT 135° SPACING: COINCIDENT	
ORTF (FRENCH BROADCASTING ORGANIZATION)	2 - CARDIOID	AXES OF MAXIMUM RESPONSE AT 110° SPACING: NEAR-COINCIDENT (7 IN.)	
NOS (DUTCH BROADCASTING FOUNDATION)	2 - CARDIOID	AXES OF MAXIMUM RESPONSE AT 90° SPACING: NEAR-COINCIDENT (12 IN.)	
STEREOSONIC	2 - BIDIRECTIONAL	AXES OF MAXIMUM RESPONSE AT 90° SPACING: COINCIDENT	
MS (MID-SIDE)	1 - CARDIOID 1 - BIDIRECTIONAL	CARDIOID FORWARD-POINTED; BIDIRECTIONAL SIDE-POINTED; SPACING: COINCIDENT	
SPACED	2 - CARDIOID OR 2 - OMNIDIRECTIONAL	ANGLE AS DESIRED SPACING: 3-10 FT.	

STEREO MICROPHONE TECHNIQUES

Introduction

The world of studio recording is much different from that of live sound reinforcement, but the fundamental characteristics of the microphones and sound are the same. It is the ability to isolate individual instruments that gives a greater element of control and freedom for creativity in the studio. Since there are no live loudspeakers, feedback is not an issue. The natural sound of the instrument may be the desired effect, or the sound source can be manipulated into a sound never heard in the natural acoustic world.

In order to achieve the desired result it is useful to understand some of the important characteristics of microphones, musical instruments, and acoustics.

SECTION TWO

Microphone Characteristics

There are three main considerations when choosing a microphone for recording applications: operating principle, frequency response, and directionality.

Operating Principle - A microphone is an example of a “transducer,” a device which changes energy from one form into another, in this case from acoustic into electrical. The type of transducer is defined by the operating principle. In the current era of recording, the two primary operating principles used in microphone design are the dynamic and the condenser.

Dynamic microphone elements are made up of a diaphragm, voice coil, and magnet which form a sound-driven electrical generator. Sound waves move the diaphragm/voice coil in a magnetic field to generate the electrical equivalent of the acoustic sound wave. The signal from the dynamic element can be used directly, without the need for additional circuitry. This design is extremely rugged, has good sensitivity and can handle the loudest possible sound pressure levels without distortion. The dynamic has some limitations at extreme high and low frequencies. To compensate, small resonant chambers are often used to extend the frequency range of dynamic microphones.

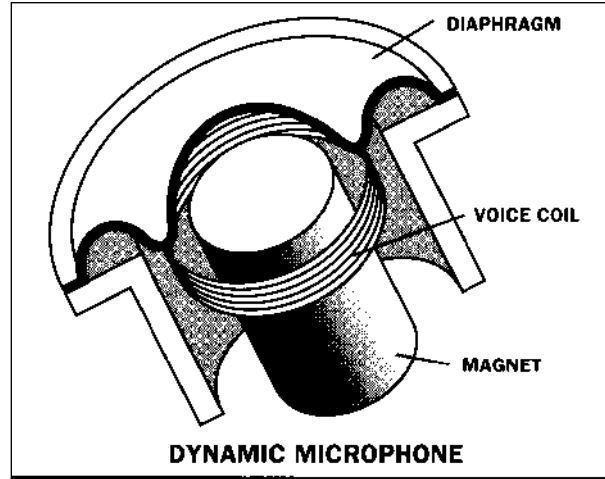

Condenser microphone elements use a conductive diaphragm and an electrically charged backplate to form a sound-sensitive “condenser” (capacitor). Sound waves move the diaphragm in an electric field to create the electrical signal. In order to use this signal from the element, all condensers have active electronic circuitry, either built into the microphone or in a separate pack. This means that condenser microphones require phantom power or a battery to operate. (For a detailed explanation of “phantom power”, see the appendix.) However, the condenser design allows for smaller mic elements, higher sensitivity and is inherently capable of smooth response across a very wide frequency range.

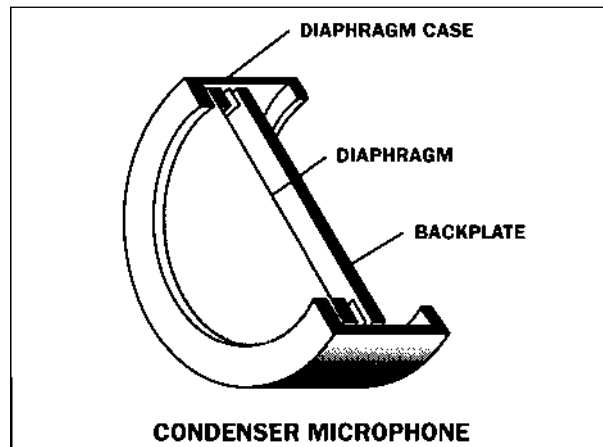

The main limitations of a condenser microphone relate to its electronics. These circuits can handle a specified maximum signal level from the condenser element, so a condenser mic has a maximum sound level before its output starts to be distorted. Some condensers have switchable pads or attenuators

between the element and the electronics to allow them to handle higher sound levels. If you hear distortion when using a condenser microphone close to a very loud sound source, first make sure that the mixer input itself is not being overloaded. If not, switch in the attenuator in the mic (if equipped), move the mic farther away, or use a mic that can handle a higher level. In any case, the microphone will not be damaged by excess level.

A second side effect of the condenser/electronics design is that it generates a certain amount of electrical noise (self-noise) which may be heard as “hiss” when recording very quiet sources at high gain settings. Higher quality condenser mics have very low self-noise, a desirable characteristic for this type of recording application.

Frequency response - *The variation in output level or sensitivity of a microphone over its useable range from lowest to highest frequency.*

Virtually all microphone manufacturers will list the frequency response of their microphones as a range, for example 20 - 20,000Hz. This is usually illustrated with a graph that indicates relative amplitude at each frequency. The graph has the frequency in Hz on the x-axis and relative response in decibels on the y-axis.

A microphone whose response is equal at all frequencies is said to have a “flat” frequency response. These microphones typically have a wide frequency range. Flat response microphones tend to be used to reproduce sound sources without coloring the original source. This is usually desired in reproducing instruments such as acoustic guitars or pianos. It is also common for stereo miking techniques and distant miking techniques.

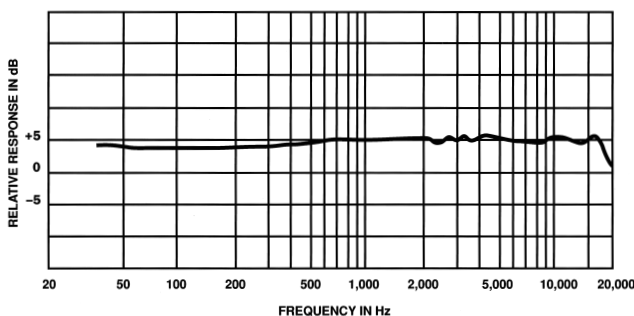

flat frequency response drawing

A microphone whose response has peaks or dips in certain frequency areas is said to have a “shaped” response. This response is designed to enhance a frequency range that is specific to a given sound source. For instance, a microphone may have a peak in the 2-10Khz range to enhance the intelligibility or presence of vocals. This shape is said to have a “presence peak”. A microphone’s response may also be reduced at other frequencies. One example of this is a low frequency roll-off to reduce unwanted “boominess”.

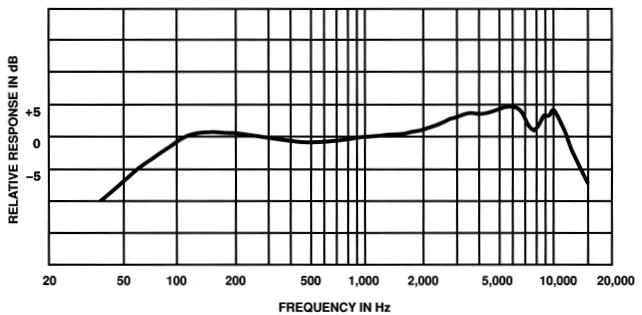

shaped frequency response drawing

Although dynamic microphones and condenser microphones may have similar published frequency response specifications their sound qualities can be quite different. A primary aspect of this difference is in their **transient response**. See the appendix for an explanation of this characteristic.

Directionality - *The sensitivity to sound relative to the direction or angle of arrival at the microphone.*

Directionality is usually plotted on a graph referred to as a polar pattern. The polar pattern shows the variation in sensitivity 360 degrees around the microphone, assuming that the microphone is in the center and 0 degrees represents the front or on-axis direction of the microphone.

There are a number of different directional patterns designed into microphones. The three basic patterns are omnidirectional, unidirectional, and bidirectional.

The **omnidirectional** microphone has equal response at all angles. Its “coverage” or pickup angle is a full 360 degrees. This type of microphone can be used if more room ambience is desired. For example, when using an “omni”, the

balance of direct and ambient sound depends on the distance of the microphone from the instrument, and can be adjusted to the desired effect.

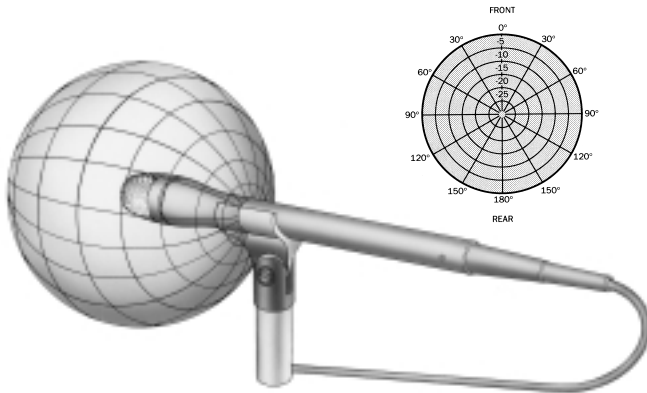

omnidirectional

The **unidirectional** microphone is most sensitive to sound arriving from one particular direction and is less sensitive at other directions. The most common type is a *cardioid* (heart-shaped) response. This has full sensitivity at 0 degrees (on-axis) and is least sensitive at 180 degrees (off-axis). Unidirectional microphones are used to isolate the desired on-axis sound from unwanted off-axis sound. In addition, the cardioid mic picks up only about one-third as much ambient sound as an omni.

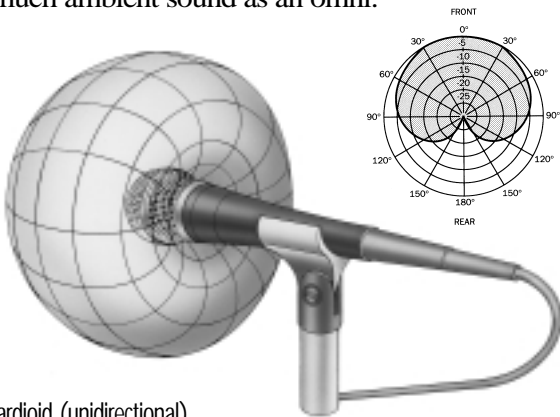

cardioid (unidirectional)

For example, the use of a cardioid microphone for a guitar amplifier, which is in the same room as the drum set, is one way to reduce the bleed-through of drums on to the recorded guitar track. The mic is aimed toward the amplifier and away from the drums. If the undesired sound source is extremely loud (as drums often are), other isolation techniques may be necessary.

Unidirectional microphones are available with several variations of the cardioid pattern. Two of these are the *supercardioid* and *hypercardioid*.

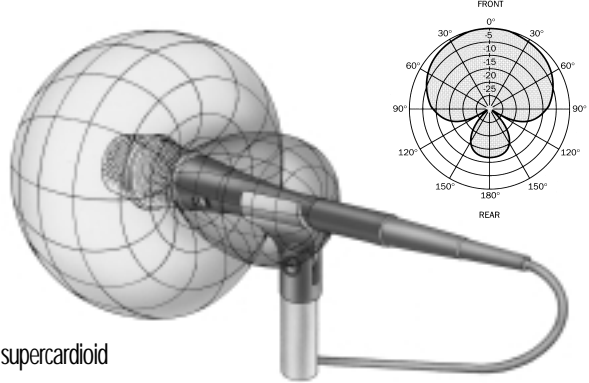

supercardioid

Both patterns offer narrower front pickup angles than the cardioid (115 degrees for the supercardioid and 105 degrees for the hypercardioid) and also greater rejection of ambient sound. While the cardioid is least sensitive at the rear (180 degrees off-axis), the least sensitive direction is at 125 degrees for the supercardioid and 110 degrees for the hypercardioid. When placed properly they can provide more “focused” pickup and less room ambience than the cardioid pattern, but they have less rejection at the rear: -12 dB for the supercardioid and only -6 dB for the hypercardioid.

The **bidirectional** microphone has full response at both 0 degrees (front) and at 180 degrees (back). It has its least response at the sides. The coverage or pickup angle is only about 90 degrees at the front (or the rear). It has the same amount of ambient pickup as the cardioid. This mic could be used for picking up two sound sources such as two vocalists facing each other. It is also used in certain stereo techniques.

CHARACTERISTIC	OMNI-DIRECTIONAL	CARDIOID	SUPER-CARDIOID	HYPER-CARDIOID	BI-DIRECTIONAL
POLAR RESPONSE PATTERN					
COVERAGE ANGLE	360°	131°	115°	105°	90°
ANGLE OF MAXIMUM REJECTION (null angle)	—	180°	126°	110°	90°
REAR REJECTION (relative to front)	0	∞	12 dB	6 dB	0
AMBIENT SOUND SENSITIVITY (relative to omni)	100%	33%	27%	25%	33%
DISTANCE FACTOR (relative to omni)	1	1.7	1.9	2	1.7

Microphone polar patterns compared

Other directional-related microphone characteristics:

Ambient sound sensitivity - Since unidirectional microphones are less sensitive to off-axis sound than omnidirectional types, they pick up less overall ambient or room sound. Unidirectional mics should be used to control ambient noise pickup to get a “cleaner” recording.

Distance factor - Since directional microphones have more rejection of off-axis sound than omnidirectional types, they may be used at greater distances from a sound source and still achieve the same balance between the direct sound and background or ambient sound. An omnidirectional microphone will pick up more room (ambient) sound than a unidirectional microphone at the same distance. An omni should be placed closer to the sound source than a “uni” – about half the distance – to pick up the same balance between direct sound and room sound.

Off-axis coloration - A microphone’s frequency response may not be uniform at all angles. Typically, high frequencies are most affected, which may result in an unnatural sound for off-axis instruments or room ambience.

Proximity effect - For most unidirectional types, bass response increases as the microphone is moved closer to the sound source. When miking close with unidirectional microphones (less than 1 foot), be aware of proximity effect: it may help to roll off the bass until you obtain a more natural sound. You can (1) roll off low frequencies at the mixer, (2) use a microphone designed to minimize proximity effect, (3) use a microphone with a bass roll-off switch, or (4) use an omnidirectional microphone (which does not exhibit proximity effect).

Understanding and choosing the frequency response and directionality of microphones are selective factors which can improve pickup of desired sound and reduce pickup of unwanted sound. This can greatly assist in achieving both natural sounding recordings and unique sounds for special applications.

Instrument Characteristics

First, let’s present a bit of background information about how instruments radiate sound. The sound from a musical instrument has a frequency output which is the range of frequencies produced and their relative amplitudes. The fundamental frequencies establish the basic pitch, while the harmonic frequencies produce the timbre or characteristic tone of the instrument. Here are frequency ranges for some commonly known instruments:

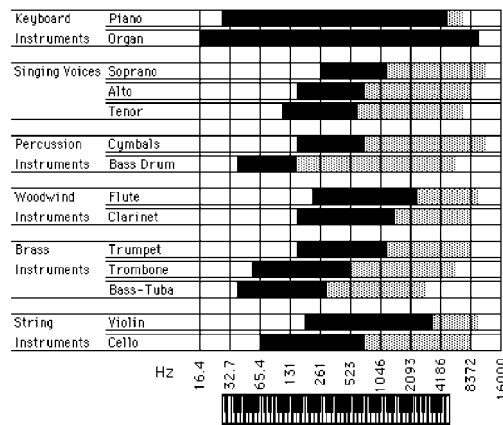

chart of instrument frequency ranges

Also, an instrument radiates different frequencies at different levels in every direction, and each part of an instrument produces a different timbre. This is the directional output of an instrument. You can partly control the recorded tonal balance of an instrument by adjusting the microphone position relative to it. The fact that low frequencies tend to be omnidirectional while higher frequencies tend to be more directional is a basic audio principle to keep in mind.

Most acoustic instruments are designed to sound best at a distance (say, two or more feet away). The sounds of the various parts of the instrument combine into a complete audio picture at some distance from the instrument. So, a microphone placed at that distance will pick up a “natural” or well-balanced tone quality. On the other hand, a microphone placed close to the instrument emphasizes the part of the instrument that the microphone is near. The sound picked up very close may or may not be the sound you wish to capture in the recording.

Acoustic Characteristics

Since room acoustics have been mentioned repeatedly, here is a brief introduction to some basic factors involved in acoustics.

Sound Waves – Sound waves consist of pressure variations traveling through the air. When the sound wave travels, it compresses air molecules together at one point. This is called the high pressure zone or positive component(+). After the compression, an expansion of molecules occurs. This is the low pressure zone or negative component(-). This process continues along the path of the sound wave until its energy becomes too weak to hear. If you could view the sound wave of a pure tone traveling through air, it would appear as a smooth, regular variation of pressure that could be drawn as a sine wave. The diagram shows the relationship of the air molecules and a sine wave.

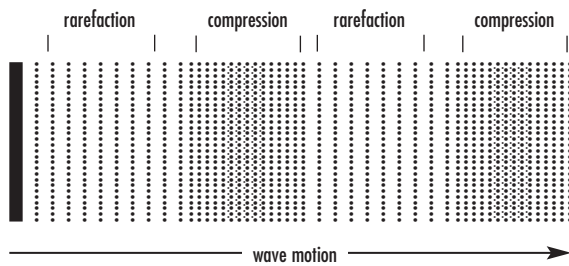

Frequency, Wavelength, and the Speed of Sound – The frequency of a sound wave indicates the rate of pressure variations or cycles. One cycle is a change from high pressure to low pressure and back to high pressure. The number of cycles per second is called Hertz, abbreviated “Hz.” So, a 1,000Hz tone has 1,000 cycles per second.

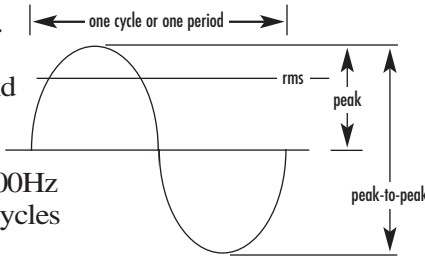

The wavelength of a sound is the physical distance from the start of one cycle to the start of the next cycle. Wavelength is related to frequency by the speed of sound. The speed of sound in air is 1130 feet per second or 344 meters/second. The speed of sound is constant no matter what the frequency. You can determine the wavelength of a sound wave of any frequency if you understand these relationships:

The Wave Equation: $c = f \cdot \lambda$
 speed of sound = frequency • wavelength
 or

$$\text{wavelength} = \frac{\text{speed of sound}}{\text{frequency}}$$
 for a 500Hz sound wave:

$$\text{wavelength} = \frac{1,130 \text{ feet per second}}{500\text{Hz}}$$

$$\text{wavelength} = 2.26 \text{ feet}$$

Approximate wavelengths of common frequencies:

100 Hz: about 10 feet
 1000 Hz: about 1 foot
 10,000 Hz: about 1 inch

Loudness – The fluctuation of air pressure created by sound is a change above and below normal atmospheric pressure. This is what the human ear responds to. The varying amount of pressure of the air molecules compressing and expanding is related to the

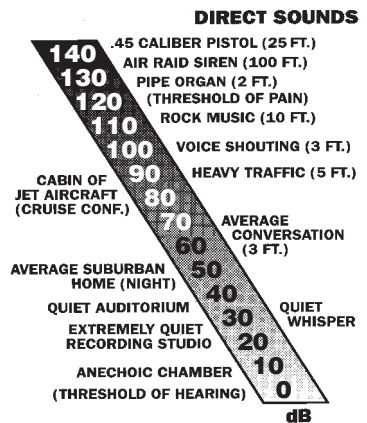

apparent loudness at the human ear. The greater the pressure change, the louder the sound. Under ideal conditions the human ear can sense a pressure change as small as .0002 microbar. One microbar is equal to one millionth of atmospheric pressure. The threshold of pain is about 200 microbar. Obviously, the human ear responds to a wide range of amplitude of sound. This amplitude range is more commonly referred to in decibels. Sound Pressure Level (dB SPL), relative to .0002 microbar (0dB SPL). 0 dB SPL is the threshold of hearing and 120 dB SPL is the threshold of pain. 1 dB is about the smallest change in SPL that can be heard. A 3 dB change is generally noticeable, while a 6 dB change is very noticeable. A 10 dB SPL increase is perceived to be twice as loud!

Sound Transmission – It is important to remember that sound transmission does not normally happen in a completely controlled environment. In a recording studio, though, it is possible to separate or isolate the sounds being recorded. The best way to do this is to put the different sound sources in different rooms. This provides almost complete isolation and control of the sound from the voice or instrument. Unfortunately, multiple rooms are not always an option in studios, and even one sound source in a room by itself is subject to the effects of the walls, floor, ceiling and various isolation barriers. All of these effects can alter the sound before it actually arrives at the microphone.

In the study of acoustics there are three basic ways in which sound is altered by its environment:

1. Reflection - A sound wave can be reflected by a surface or other object if the object is physically as large or larger than the wavelength of the sound. Because low-frequency sounds have long wavelengths, they can only be reflected by large objects. Higher frequencies can be reflected by smaller objects and surfaces. The reflected sound will have a different frequency characteristic than the direct sound if all sounds are not reflected equally. Reflection is also the source of echo, reverb, and standing waves:

Echo occurs when an indirect sound is delayed long enough (by a distant reflective surface) to be heard by the listener as a distinct repetition of the direct sound.

Reverberation consists of many reflections of a sound, maintaining the sound in a room for a time even after the direct sound has stopped.

Standing waves in a room occur for certain frequencies related to the distance between parallel walls. The original sound and the reflected sound will begin to reinforce each other when the wavelength is equal to the distance between two walls. Typically, this happens at low frequencies due to their longer wavelengths and the difficulty of absorbing them.

2. Refraction - The bending of a sound wave as it passes through some change in the density of the transmission environment. This change may be due to physical objects, such as blankets hung

for isolation or thin gobos, or it may be due to atmospheric effects such as wind or temperature gradients. These effects are not noticeable in a studio environment.

3. Diffraction - A sound wave will typically bend around obstacles in its path which are smaller than its wavelength. Because a low frequency sound wave is much longer than a high frequency wave, low frequencies will bend around objects that high frequencies cannot. The effect is that high frequencies are more easily blocked or absorbed while low frequencies are essentially omnidirectional. When isolating two instruments in one room with a gobo as an acoustic barrier, it is possible to notice the individual instruments are “muddy” in the low end response. This may be due to diffraction of low frequencies around the acoustic barrier.

APPLICATIONS TIP:

Absorption (beware of carpets!)

When building a project studio or small commercial studio, it is usually necessary to do some sound treatment to the walls and possibly build some isolating gobos for recording purposes. Many small studios assume they can save money and achieve the desired absorption effect by using inexpensive carpet. This is a bad assumption.

Absorption is the changing of sound energy into heat as it tries to pass through some material. Different materials have different absorption effects at multiple frequencies. Each material is measured with an absorption coefficient ranging between 0-1 (sabins). This can be thought of as the percentage of sound that will be absorbed.

For instance: a material may have an absorption coefficient of .67 at 1,000 Hz. This would mean the material absorbs 67% of the 1,000 Hz frequencies applied to it.

Here is a chart showing the advantages of acoustic foam over bare walls or carpeting.

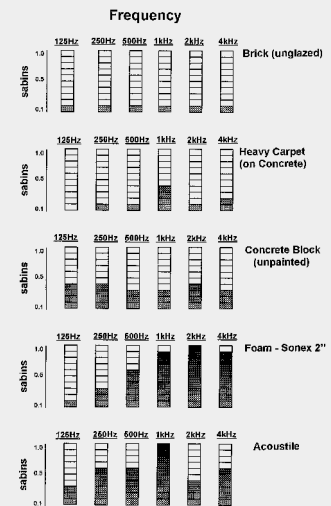

Direct vs. Ambient Sound – A very important property of direct sound is that it becomes weaker as it travels away from the sound source, at a rate controlled by the *inverse-square law*. When the distance from a sound source doubles, the sound level decreases by 6dB. This is a noticeable audible decrease. For example, if the sound from a guitar amplifier is 100 dB SPL at 1 ft. from the cabinet it will be 94 dB at 2 ft., 88 dB at 4 ft., 82 dB at 8 ft., etc. When the distance is cut in half the sound level increases by 6dB: It will be 106 dB at 6 inches and 112 dB at 3 inches.

On the other hand, the ambient sound in a room is at nearly the same level throughout the room. This is because the ambient sound has been reflected many times within the room until it is essentially non-directional. Reverberation is an example of non-directional sound.

This is why the ambient sound of the room will become increasingly apparent as a microphone is placed further away from the direct sound source. The amount of direct sound relative to ambient sound can be controlled by the distance of the microphone to the sound source and to a lesser degree by the polar pattern of the mic.

However, if the microphone is placed beyond a certain distance from the sound source, the ambient sound will begin to dominate the recording and the desired balance may not be possible to achieve, no matter what type of mic is used. This is called the *“critical distance”* and becomes shorter as the ambient noise and reverberation increase, forcing closer placement of the microphone to the source.

Phase relationships and interference effects –

The phase of a single frequency sound wave is always described relative to the starting point of the wave or 0 degrees.

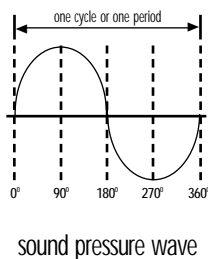

of the wave or 0 degrees. The pressure change is also zero at this point. The peak of the high pressure zone is at 90 degrees, and the pressure change falls to zero again at 180 degrees.

The peak of the low pressure zone is at 270 degrees, and the pressure change rises to zero at 360 degrees for the start of the next cycle.

Two identical sound waves starting at the same point in time are called “in-phase” and will sum together creating a single wave with double the amplitude but otherwise identical to the original waves.

Two identical sound waves with one wave’s starting point occurring at the 180-degree point of the other wave are said to be “out of phase”, and the two waves will cancel each other completely.

When two sound waves of the same single frequency but different

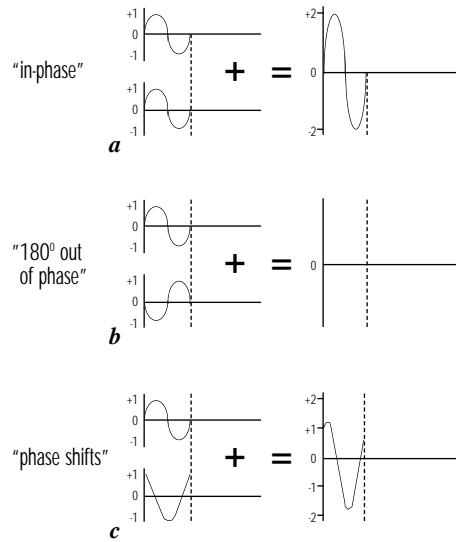

phase relationships

starting points are combined, the resulting wave as said to have “phase shift” or an apparent starting point somewhere between the original starting points. This new wave will have the same frequency as the original waves but will have increased or decreased amplitude depending on the degree of phase difference. Phase shift, in this case, indicates that the 0 degree points of two identical waves are not the same.

Most soundwaves are not a single frequency but are made up of many frequencies. When identical multiple-frequency soundwaves combine, there are three possibilities for the resulting wave: a doubling of amplitude at all frequencies if the waves are “in phase”, a complete cancellation at all frequencies if the waves are 180 degrees “out of phase”, or partial cancellation and partial reinforcement at various frequencies if the waves have intermediate phase relationship.

The last case is the most likely, and the audible result is a degraded frequency response called “comb filtering.” The pattern of peaks and dips resembles the teeth of a comb and the depth and location of these notches depend on the degree of phase shift.

With microphones this effect can occur in two ways. The first is when two (or more) mics pick up the same sound source at different distances. Because it takes longer for the sound to arrive at the more distant microphone, there is effectively a phase difference between the signals from the mics when they are combined (electrically) in the mixer. The resulting comb filtering depends on the sound arrival time difference between the microphones: a large time difference (long distance) causes comb filtering to begin at low frequencies, while a small time difference (short distance) moves the comb filtering to higher frequencies.

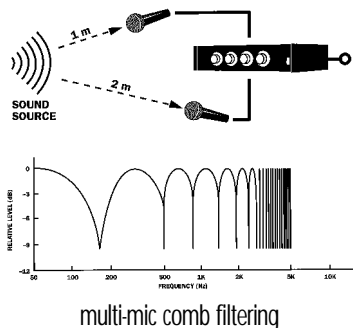

multi-mic comb filtering

The second way for this effect to occur is when a single microphone picks up a direct sound and also a delayed version of the same sound. The delay may be due to an acoustic

reflection of the original sound or to multiple sources of the original sound. A guitar cabinet with more than one speaker or multiple cabinets for the same instrument would be an example. The delayed sound travels a longer distance (longer

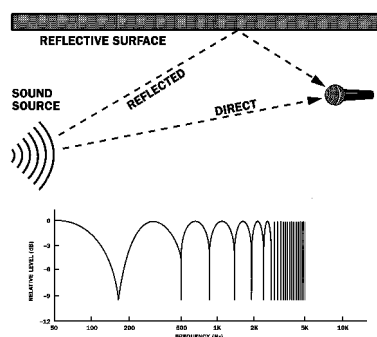

reflection comb filtering

time) to the mic and thus has a phase difference relative to the direct sound. When these sounds combine (acoustically) at the microphone, comb filtering results. This time the effect of the comb filtering

depends on the distance between the microphone and the source of the reflection or the distance between the multiple sources.

The goal here is to create an awareness of the sources of these potential influences on recorded sound and to provide insight into controlling them. When an effect of this sort is heard, and is undesirable, it is usually possible to move the sound source, use a microphone with a different directional characteristic, or physically isolate the sound source further to improve the situation.

APPLICATIONS TIP: Microphone phase

One of the strangest effects that can happen in the recording process is apparent when two microphones are placed in close proximity to the same sound source. Many times this is due to the phase relationship of the sounds arriving at the microphones. If two microphones are picking up the same sound source from different locations, some phase cancellation or summing may be occurring. Phase cancellation happens when two microphones are receiving the same soundwave but with opposite pressure zones (that is, more than 180 degrees out of phase). This is usually not desired. A mic with a different polar pattern may reduce the pickup of unwanted sound and reduce the effect, or physical isolation can be used. With a drum kit, physical isolation of the individual drums is not possible. In this situation your choice of microphones may be more dependent on the off-axis rejection of the mic.

Another possibility is phase reversal. If there is cancellation occurring, a 180 degree phase flip will create phase summing of the same frequencies. A common approach to the snare drum is to place one mic on the top head and one on the bottom head. Because the mics are picking up relatively similar sound sources at different points in the sound wave, you are probably experiencing some phase cancellations. Inverting the phase of one mic will sum any frequencies being canceled. This may sometimes achieve a “fatter” snare drum sound. This effect will change dependent on mic locations. The phase inversion can be done with an in-line phase reverse adapter or by a phase invert switch found on many mixer inputs.

Shure Microphone Selection Guide

Vocal

Live Vocals

Beta58A
SM58
Beta54
Beta87A
Beta87C
SM87A
SM86
PG58
55SH Series II
WH30

Studio Vocals

KSM44
KSM32
KSM27
SM7B
Beta87A
Beta87C
SM87A
SM86

Studio Ensemble Vocals

KSM44
KSM32
KSM27
KSM141
KSM137
KSM109

Live Choirs

MX202
EZO
SM81
SM94
PG81

Karaoke

SM58S
SM48S
565
PG58
PG48

Spoken Word

Beta53
SM48
PG48

Instrument

Studio Instrument

KSM141
KSM137
KSM109
KSM44
KSM32
KSM27
SM81

Orchestra

KSM141
KSM137
KSM109
KSM44
KSM32
KSM27
SM81
SM94
PG81

Strings

KSM141
KSM137
KSM109
KSM44
KSM32
KSM27
SM81
SM94
PG81
Beta98S

Woodwinds

KSM44
KSM32
KSM27
KSM141
KSM137
KSM109
SM81
Beta98H/C
Beta98 S¹
PG81

Brass / Saxophone

Beta98H/C
KSM44
KSM32
KSM27
Beta57A
Beta98S
Beta56A
SM57
PG56
PG57

Acoustic Guitar

KSM141
KSM137
KSM109
KSM44
KSM32
KSM27
SM81
Beta57A
SM57
PG81
PG57

Acoustic Bass

KSM44
KSM32
KSM27
KSM141
KSM137
KSM109
Beta52A
SM81
SM94
PG81

Guitar Amp

Beta56A
Beta57A
SM57
KSM141
KSM137
KSM109
KSM44
KSM32
KSM27
SM94
PG57

Bass Amp

Beta52A
SM7B
Beta57A
Beta56A
SM57
PG52
SM94
PG57
PG81

Leslie Speaker

KSM44
KSM32
KSM27
Beta91
Beta57A
Beta56A
SM57

Piano / Organ

KSM44
KSM32
KSM27
KSM141
KSM137
KSM109
SM81
Beta91
PG81
SM94
MX202

Harmonica

520DX
SM57
SM58
PG57

Drum

Kick Drum

Beta52A
Beta91
PG52
Beta57A
SM57

Snare Drum²

Beta57A^{2,3}
Beta56A²
SM57^{2,3}
PG56
PG57^{2,3}

Rack / Floor Toms

Beta98D/S
Beta57A^{2,3}
Beta56A²
SM57^{2,3}
PG56
PG57^{2,3}

Congas

Beta98D/S
Beta56A²
Beta57A²
SM57²
PG56
PG57²

Cymbals

KSM141
KSM137
KSM109
KSM44
KSM32
KSM27
SM81
SM94
PG81

Mallets

KSM44
KSM32
KSM27
KSM141
KSM137
KSM109
SM81
SM94
PG81

Percussion

KSM141
KSM137
KSM109
KSM44
KSM32
KSM27
SM81
Beta57A
SM57
PG57

Other

Sampling / Effects

KSM44
KSM32
KSM27
KSM141
KSM137
KSM109
VP88
SM81
SM94

Live Stereo Recording

KSM141(pair)⁴
KSM137(pair)⁴
KSM109(pair)⁴
KSM44(pair)⁴
KSM32(pair)⁴
KSM27(pair)⁴
SM81(pair)⁴
SM94(pair)⁴
VP88
(M-S stereo)

Voice-Over

KSM44
KSM32
KSM27
SM7B
Beta58A
SM58
SM81⁵
Beta87C
Beta87A

¹ Bell mounted with A98KCS clamp.

² A56D enables microphone to mount on rim.

³ A50D enables microphone to mount on rim.

⁴ For optimum flexibility, use A27M stereo microphone mount.

⁵ With A81G.

3-to-1 Rule - When using multiple microphones, the distance between microphones should be at least 3 times the distance from each microphone to its intended sound source.

Absorption - The dissipation of sound energy by losses due to sound absorbent materials.

Active Circuitry - Electrical circuitry which requires power to operate, such as transistors and vacuum tubes.

Ambience - Room acoustics or natural reverberation.

Amplitude - The strength or level of sound pressure or voltage.

Audio Chain - The series of interconnected audio equipment used for recording or PA.

Backplate - The solid conductive disk that forms the fixed half of a condenser element.

Balanced - A circuit that carries information by means of two equal but opposite polarity signals, on two conductors.

Bidirectional Microphone - A microphone that picks up equally from two opposite directions. The angle of best rejection is 90 degrees from the front (or rear) of the microphone, that is, directly at the sides.

Boundary/Surface Microphone - A microphone designed to be mounted on an acoustically reflective surface.

Cardioid Microphone - A unidirectional microphone with moderately wide front pickup (131 degrees). Angle of best rejection is 180 degrees from the front of the microphone, that is, directly at the rear.

Cartridge (Transducer) - The element in a microphone that converts acoustical energy (sound) into electrical energy (the signal).

Clipping Level - The maximum electrical output signal level (dBV or dBu) that the microphone can produce before the output becomes distorted.

Close Pickup - Microphone placement within 2 feet of a sound source.

Comb Filtering - An interference effect in which the frequency response exhibits regular deep notches.

Condenser Microphone - A microphone that generates an electrical signal when sound waves vary the spacing between two charged surfaces: the diaphragm and the backplate.

Critical Distance - In acoustics, the distance from a sound source in a room at which the direct sound level is equal to the reverberant sound level.

Current - Charge flowing in an electrical circuit. Analogous to the amount of a fluid flowing in a pipe.

Decibel (dB) - A number used to express relative output sensitivity. It is a logarithmic ratio.

Diaphragm - The thin membrane in a microphone which moves in response to sound waves.

Diffraction - The bending of sound waves around an object which is physically smaller than the wavelength of the sound.

Direct Sound - Sound which travels by a straight path from a sound source to a microphone or listener.

Distance Factor - The equivalent operating distance of a directional microphone compared to an omnidirectional microphone to achieve the same ratio of direct to reverberant sound.

Distant Pickup - Microphone placement farther than 2 feet from the sound source.

Dynamic Microphone - A microphone that generates an electrical signal when sound waves cause a conductor to vibrate in a magnetic field. In a moving-coil microphone, the conductor is a coil of wire attached to the diaphragm.

Dynamic Range - The range of amplitude of a sound source. Also, the range of sound level that a microphone can successfully pick up.

Echo - Reflection of sound that is delayed long enough (more than about 50 msec.) to be heard as a distinct repetition of the original sound.

Electret - A material (such as Teflon) that can retain a permanent electric charge.

EQ - Equalization or tone control to shape frequency response in some desired way.

Feedback - In a PA system consisting of a microphone, amplifier, and loudspeaker, feedback is the ringing or howling sound caused by amplified sound from the loudspeaker entering the microphone and being re-amplified.

Flat Response - A frequency response that is uniform and equal at all frequencies.

Frequency - The rate of repetition of a cyclic phenomenon such as a sound wave.

Frequency Response Tailoring Switch - A switch on a microphone that affects the tone quality reproduced by the microphone by means of an equalization circuit. (Similar to a bass or treble control on a hi-fi receiver.)

Frequency Response - A graph showing how a microphone responds to various sound frequencies. It is a plot of electrical output (in decibels) vs. frequency (in Hertz).

Fundamental - The lowest frequency component of a complex waveform such as musical note. It establishes the basic pitch of the note.

Gain - Amplification of sound level or voltage.

Gain-Before-Feedback - The amount of gain that can be achieved in a sound system before feedback or ringing occurs.

Gobos - Movable panels used to reduce reflected sound in the recording environment.

Harmonic - Frequency components above the fundamental of a complex waveform. They are generally multiples of the fundamental which establish the timbre or tone of the note.

Hypercardioid - A unidirectional microphone with tighter front pickup (105 degrees) than a supercardioid, but with more rear pickup. Angle of best rejection is about 110 degrees from the front of the microphone.

Impedance - In an electrical circuit, opposition to the flow of alternating current, measured in ohms. A high-impedance microphone has an impedance of 10,000 ohms or more. A low-impedance microphone has an impedance of 50 to 600 ohms.

Interference - Destructive combining of sound waves or electrical signals due to phase differences.

Inverse Square Law - States that direct sound levels increase (or decrease) by an amount proportional to the square of the change in distance.

Isolation - Freedom from leakage; the ability to reject unwanted sounds.

Leakage - Pickup of an instrument by a microphone intended to pick up another instrument. Creative leakage is artistically favorable leakage that adds a "loose" or "live" feel to a recording.

Maximum Sound Pressure Level - The maximum acoustic input signal level (dB SPL) that the microphone can accept before clipping occurs.

Microphone Sensitivity - A rating given in dBV to express how “hot” the microphone is by exposing the microphone to a specified sound field level (typically either 94 dB SPL or 74 dB SPL). This specification can be confusing because manufacturers designate the sound level different ways. Here is an easy reference guide: 94 dB SPL = 1 Pascal = 10 microbars.

To compare a microphone that has been measured at 74 dB SPL with one that has been measured at 94 dB SPL, simply add 20 to the dBV rating.

NAG - Needed Acoustic Gain is the amount of gain that a sound system must provide for a distant listener to hear as if he or she was close to the unamplified sound source.

Noise - Unwanted electrical or acoustic interference.

Noise Cancelling - A microphone that rejects ambient or distant sound.

NOM - Number of open microphones in a sound system. Decreases gain-before-feedback by 3dB everytime NOM doubles.

Omnidirectional Microphone - A microphone that picks up sound equally well from all directions.

Output Noise (Self-Noise) - The amount of residual noise (dB SPL) generated by the electronics of a condenser microphone.

Overload - Exceeding the signal level capability of a microphone or electrical circuit.

PAG - Potential Acoustic Gain is the calculated gain that a sound system can achieve at or just below the point of feedback.

Phantom Power - A method of providing power to the electronics of a condenser microphone through the microphone cable.

Phase - The “time” relationship between cycles of different waves.

Pickup Angle/Coverage Angle - The effective arc of coverage of a microphone, usually taken to be within the 3dB down points in its directional response.

Pitch - The fundamental or basic frequency of a musical note.

Polar Pattern (Directional Pattern, Polar Response) - A graph showing how the sensitivity of a microphone varies with the angle of the sound source, at a particular frequency. Examples of polar patterns are unidirectional and omnidirectional.

Polarization - The charge or voltage on a condenser microphone element.

Pop Filter - An acoustically transparent shield around a microphone cartridge that reduces popping sounds. Often a ball-shaped grille, foam cover or fabric barrier.

Pop - A thump of explosive breath sound produced when a puff of air from the mouth strikes the microphone diaphragm. Occurs most often with “p”, “t”, and “b” sounds.

Presence Peak - An increase in microphone output in the “presence” frequency range of 2,000 Hz to 10,000 Hz. A presence peak increases clarity, articulation, apparent closeness, and “punch.”

Proximity Effect - The increase in bass occurring with most unidirectional microphones when they are placed close to an instrument or vocalist (within 1 foot). Does not occur with omnidirectional microphones.

Rear Lobe - A region of pickup at the rear of a supercardioid or hypercardioid microphone polar pattern. A bidirectional microphone has a rear lobe equal to its front pickup.

Reflection - The bouncing of sound waves back from an object or surface which is physically larger than the wavelength of the sound.

Refraction - The bending of sound waves by a change in the density of the transmission medium, such as temperature gradients in air due to wind.

Resistance - The opposition to the flow of current in an electrical circuit. It is analogous to the friction of fluid flowing in a pipe.

Reverberation - The reflection of a sound a sufficient number of times that it becomes non-directional and persists for some time after the source has stopped. The amount of reverberation depends on the relative amount of sound reflection and absorption in the room.

Rolloff - A gradual decrease in response below or above some specified frequency.

Sensitivity - The electrical output that a microphone produces for a given sound pressure level.

Shaped Response - A frequency response that exhibits significant variation from flat within its range. It is usually designed to enhance the sound for a particular application.

Signal to Noise Ratio - The amount of signal (dBV) above the noise floor when a specified sound pressure level is applied to the microphone (usually 94 dB SPL).

Sound Chain - The series of interconnected audio equipment used for recording or PA.

Sound Reinforcement - Amplification of live sound sources.

Speed of Sound - The speed of sound waves, about 1130 feet per second in air.

SPL - Sound Pressure Level is the loudness of sound relative to a reference level of 0.0002 microbars.

Standing Wave - A stationary sound wave that is reinforced by reflection between two parallel surfaces that are spaced a wavelength apart.

Supercardioid Microphone - A unidirectional microphone with tighter front pickup angle (115 degrees) than a cardioid, but with some rear pickup. Angle of best rejection is 126 degrees from the front of the microphone, that is, 54 degrees from the rear.

3-to-1 Rule - (See top of page 29.)

Timbre - The characteristic tone of a voice or instrument; a function of harmonics.

Transducer - A device that converts one form of energy to another. A microphone transducer (cartridge) converts acoustical energy (sound) into electrical energy (the audio signal).

Transient Response - The ability of a device to respond to a rapidly changing input.

Unbalanced - A circuit that carries information by means of one signal on a single conductor.

Unidirectional Microphone - A microphone that is most sensitive to sound coming from a single direction-in front of the microphone. Cardioid, supercardioid, and hypercardioid microphones are examples of unidirectional microphones.

Voice Coil - Small coil of wire attached to the diaphragm of a dynamic microphone.

Voltage - The potential difference in an electric circuit. Analogous to the pressure on fluid flowing in a pipe.

Wavelength - The physical distance between the start and end of one cycle of a soundwave.

Appendix A: The Decibel

The decibel (dB) is an expression often used in electrical and acoustic measurements. The decibel is a number that represents a ratio of two values of a quantity such as voltage. It is actually a logarithmic ratio whose main purpose is to scale a large measurement range down to a much smaller and more useable range. The form of the decibel relationship for voltage is:

$$\text{dB} = 20 \times \log(V1/V2)$$

where 20 is a constant, V1 is one voltage, V2 is a reference voltage, and log is logarithm base 10.

Examples:

What is the relationship in decibels between 100 volts and 1 volt? (dBV)

$$\begin{aligned} \text{dB} &= 20 \times \log(100/1) \\ \text{dB} &= 20 \times \log(100) \\ \text{dB} &= 20 \times 2 \quad (\text{the log of } 100 \text{ is } 2) \\ \text{dB} &= 40 \end{aligned}$$

That is, 100 volts is 40dB greater than 1 volt.

What is the relationship in decibels between .0001 volt and 1 volt? (dBV)

$$\begin{aligned} \text{dB} &= 20 \times \log(.0001/1) \\ \text{dB} &= 20 \times \log(.0001) \\ \text{dB} &= 20 \times (-3) \quad (\text{the log of } .0001 \text{ is } -3) \\ \text{dB} &= -60 \end{aligned}$$

That is, .0001 volt is 60dB less than 1 volt.

Similarly:

If one voltage is equal to the other, they are 0dB different.

If one voltage is twice the other, they are 6dB different.

If one voltage is ten times the other, they are 20dB different.

Since the decibel is a ratio of two values, there must be an explicit or implicit reference value for any measurement given in dB. This is usually indicated by a suffix on the dB. Some devices are measured in dBV (reference to 1 Volt = 0 dBV), while others may be specified in dBu or dBm (reference to .775V = 0dBu/dBm). Here is a chart that makes conversion for comparison easy:

Audio equipment signal levels are generally broken into 3 main categories: Mic, Line, or Speaker Level. Aux level resides within the lower half of line level. The chart also shows at what voltages these categories exist.

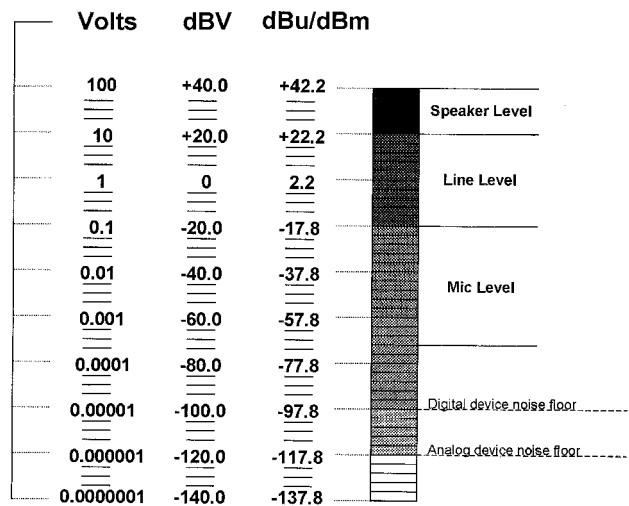

Conversions for our use:
 dBu = dBm
 dBV = dBm - 2.2
 dBu = dBV + 2.2

Formulas for our use:
 dBV = 20 log (volts)
 dBu = 20 log (volts/.775)

One reason that the decibel is so useful in certain audio measurements is that this scaling function closely approximates the behavior of human hearing sensitivity. For example, a change of 1dB SPL is about the smallest difference in loudness that can be perceived while a 3dB SPL change is generally noticeable. A 6dB SPL change is quite noticeable and finally, a 10dB SPL change is perceived as “twice as loud.”

Appendix B: Transient Response

The ability of a microphone to respond to a rapidly changing sound wave.

A good way to understand why dynamic and condenser mics sound different is to understand the differences in their transient response.

In order for a microphone to convert sound energy into electrical energy, the sound wave must physically move the diaphragm of the microphone. The speed of this movement depends on the weight or mass of the diaphragm. For instance, the diaphragm and voice coil assembly of a dynamic microphone may have up to 1000 times the mass of the diaphragm of a condenser microphone. The lightweight condenser diaphragm starts moving much more quickly than the dynamic's diaphragm. It also takes longer for the dynamic's diaphragm to stop moving in comparison to the condenser's diaphragm. Thus, the dynamic's transient response is not as good as the condenser's transient response. This is similar to two vehicles in traffic: a truck and a sports car. They may have engines of equal power, but the truck weighs much more than the car. As traffic flow changes, the sports car can accelerate and brake very quickly, while the semi accelerates and brakes very slowly due to its greater weight. Both vehicles follow the overall traffic flow but the sports car responds better to sudden changes.

The picture below is of two studio microphones responding to the sound impulse produced by an electric spark: condenser mic on top, dynamic mic on bottom. It is evident that it takes almost twice as long for the dynamic microphone to respond to the sound. It also takes longer for the dynamic to stop moving after the impulse has passed (notice the ripple on the second half of the graph). Since condenser microphones generally have better transient response than dynamics, they are better suited for instruments that have very sharp attacks or extended high frequency output such as cymbals. It is this transient response difference that causes condenser mics to have a more crisp, detailed sound and dynamic mics to have a more mellow, rounded sound.

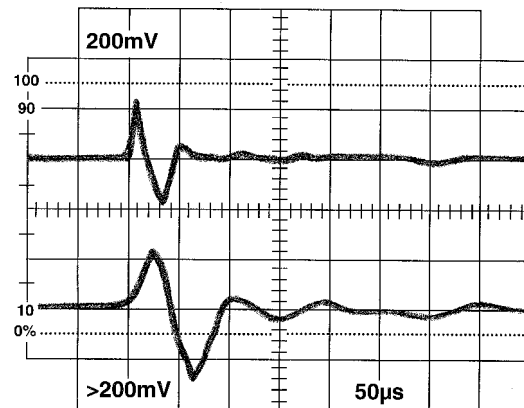

condenser/dynamic scope photo

JOHN BOUDREAU John, a lifelong Chicago native, has had extensive experience as a musician, a recording engineer, and a composer. His desire to better combine the artistic and technical aspects of music led him to a career in the audio field.

Having received a BS degree in Music Business from Elmhurst College, John performed and composed for both a Jazz and a Rock band prior to joining Shure in 1994 as an associate in the Applications Engineering group. While at Shure, John led many audio product training seminars and clinics, with an eye to helping musicians and others affiliated with the field use technology to better fulfill their artistic interpretations.

No longer a Shure associate, John continues to pursue his interests as a live and recorded sound engineer for local bands and venues, as well as writing and recording for his own band.

RICK FRANK Over his career, Rick has been involved in a wide variety of music and recording activities including composing, teaching, performing, and producing popular music, jazz and commercial jingles. He has spent his life in Illinois where he received his BS in English and his MBA from the University of Illinois, Urbana-Champaign. While in downstate Illinois he also operated a successful retail musical instrument business and teaching program that coincided with working as a professional guitarist and electric bassist.

Rick's work at Shure began as Marketing Specialist for Music and Sound Reinforcement where he was responsible for researching and analyzing new product concepts and introducing new wired and wireless products to the global market. He has presented training seminars to audiences and written instructional materials on a variety of audio subjects including Understanding Sound Reinforcement using the Potential Acoustic Gain Equation.

He is currently Marketing Director for Wired Microphones at Shure where he is responsible for Music industry products including microphones and other products for recording and he continues to perform music professionally.

TIM VEAR Tim is a native of Chicago who has come to the audio field as a way of combining a lifelong interest in both entertainment and science. He has worked as an engineer in live sound, recording and broadcast, has operated his own recording studio and sound company, and has played music professionally since high school.

At the University of Illinois, Urbana-Champaign, Tim earned a BS in Aeronautical and Astronautical Engineering with a minor in Electrical Engineering. During this time he also worked as chief technician for both the Speech and Hearing Science and Linguistics departments.

In his tenure at Shure, Tim has served in a technical support role for the sales and marketing departments, providing product and applications training for Shure customers, dealers, installers, and company staff. He has presented seminars for a variety of domestic and international audiences, including the National Systems Contractors Association, the Audio Engineering Society and the Society of Broadcast Engineers. Tim has authored several publications for Shure and his articles have appeared in several trade publications.

RICK WALLER Now residing in the Chicago area, Rick grew up near Peoria, Illinois. An interest in the technical and musical aspects of audio has led him to pursue a career as both engineer and musician. He received a BS degree in Electrical Engineering from the University of Illinois at Urbana/Champaign, where he specialized in acoustics, audio synthesis and radio frequency theory. Rick is an avid keyboardist, drummer and home theater hobbyist and has also worked as a sound engineer and disc jockey. Currently he is an associate in the Applications Engineering Group at Shure. In this capacity Rick provides technical support to customers, writing and conducting seminars on wired and wireless microphones, mixers and other audio topics.

Additional Shure Publications Available:

- Selection and Operation of Personal Monitor Systems
- Selection and Operation of Wireless Microphone Systems
- Microphone Techniques for Live Sound Reinforcement
- Shure/Tascam Guide to Microphones and Multitrack Recorders

These educational publications are available free of charge, as are brochures and catalogs on our full line of sound reinforcement and recording products.

To request your complimentary copies, please contact us.

Other Sources of Information:

There are books written about acoustics and how to mathematically determine their effects. Here are a few:

- FUNDAMENTALS OF MUSICAL ACOUSTICS by Arthur H. Benade
- ACOUSTICS SOURCE BOOK by Sybil P. Parker
- MODERN RECORDING TECHNIQUES by Huber & Runstein
- THE MASTER HANDBOOK OF ACOUSTICS by F. Alton Everest

Our Dedication to Quality Products

Shure offers a complete line of microphones and wireless microphone systems for everyone from first-time users to professionals in the music industry—for nearly every possible application.

For over seven decades, the Shure name has been synonymous with quality audio.

All Shure products are designed to provide consistent, high-quality performance under the most extreme real-life operating conditions.



www.shure.com

United States:
Shure Incorporated
5800 West Touhy Avenue
Niles, IL 60714-4608 USA

Phone: 847-600-2000
Fax: 847-600-1212
E-mail: info@shure.com

**Europe, Middle East,
Africa:**
Shure Europe GmbH
Wannenäckerstr. 28,
74078 Heilbronn, Germany

Phone: 49-7131-72140
Fax: 49-7131-721414
E-mail: info@shure.de

Asia, Pacific:
Shure Asia Limited
Unit 301, 3rd Floor
Citicorp Centre
18, Whitfield Road
Causeway Bay, Hong Kong

Phone: 852-2893-4290
Fax: 852-2893-4055
E-mail: info@shure.com.hk

**Canada, Latin America,
Caribbean:**
Shure Incorporated
5800 West Touhy Avenue
Niles, IL 60714-4608 USA

Phone: 847-600-2000
Fax: 847-600-6446
E-mail: international@shure.com